



INSTYTUT TECHNIKI BUDOWLANEJ
PL 00-611 WARSZAWA
ul. Filtrowa 1
tel.: (+48 22) 825-04-71
(+48 22) 825-76-55
fax: (+48 22) 825-52-86
www.itb.pl



Member of



European Technical Assessment

**ETA-13/0937
of 23/02/2017**

General Part

Technical Assessment Body issuing the European Technical Assessment

Instytut Techniki Budowlanej

Trade name of the construction product

SIMPSON STRONG-TIE® - VINYLESTER ADHESIVE SYSTEM „VA”

Product family to which the construction product belongs

Bonded anchor with anchor rod of sizes M8 to M30 made of galvanized steel or stainless steel for use in non-cracked concrete

Manufacturer

SIMPSON STRONG-TIE® GmbH
Hubert-Vergölst-Straße 6-14
61231 Bad Nauheim
Germany

Manufacturing plant

SIMPSON STRONG-TIE®
Manufacturing Facilities (Plant 8)

This European Technical Assessment contains

14 pages including 3 Annexes which form an integral part of this Assessment

This European Technical Assessment is issued in accordance with Regulation (EU) No 305/2011, on the basis of

Guideline for European Technical Approval ETAG 001, Edition April 2013 “Metal anchors for use in concrete – Part 1: Anchors in general and Part 5: Bonded anchors”, used as European Assessment Document (EAD)

This version replaces

ETA-13/0937 issued on 26/06/2013

This European Technical Assessment is issued by the Technical Assessment Body in its official language. Translations of this European Technical Assessment in other languages shall fully correspond to the original issued document and should be identified as such.

Communication of this European Technical Assessment, including transmission by electronic means, shall be in full. However, partial reproduction may be made, with the written consent of the issuing Technical Assessment Body. Any partial reproduction has to be identified as such.

Specific Part

1 Technical description of the product

The SIMPSON STRONG-TIE® - VINYLESTER ADHESIVE SYSTEM „VA” is a bonded anchor (capsule type) consisting of chemical mortar glass capsules VAC and threaded anchor rod VAS of sizes M8 to M30 made of:

- galvanized carbon steel,
 - stainless steel,
 - high corrosion resistant stainless steel,
- with hexagon nut and washer.

The glass capsule is placed into a drilled hole previously cleaned and the threaded rod is driven by machine with simultaneous hammering and turning. The threaded rod is anchored by the bond between threaded rod, chemical mortar and concrete.

The threaded rods are available for all diameters with two type of tip end: a one side 45° chamfer or a two sides 45° chamfer.

An illustration and description of the products are given in Annexes A.

2 Specification of the intended use in accordance with the applicable European Assessment Document (EAD)

The performances given in Section 3 are only valid if the anchors are used in compliance with the specifications and conditions given in Annexes B.

The performances given in this European Technical Assessment are based on an assumed working life of the anchor of 50 years. The indications given on the working life cannot be interpreted as a guarantee given by the producer or the Technical Assessment Body, but are to be regarded only as a means for choosing the right products in relation to the expected economically reasonable working life of the works.

3 Performance of the product and references to the methods used for its assessment

3.1 Performance of the product

3.1.1 Mechanical resistance and stability (BWR 1)

The essential characteristic is detailed in the Annexes C.

3.1.2 Safety in case of fire (BWR 2)

Essential characteristics	Performances
Reaction to fire	Anchorage satisfy requirements for Class A1
Resistance to fire	No performance assessed

3.1.3 Hygiene, health and the environment (BWR 3)

Regarding dangerous substances there may be requirements applicable to the products falling within its scope (e.g. transposed European legislation and national

laws, regulations and administrative provisions). In order to meet the provisions of the Construction Products Regulation, these requirements need also to be complied with, when and where they apply.

3.1.4 Safety and accessibility in use (BWR 4)

For Basic Requirement Safety in use the same criteria are valid as for Basic Requirement Mechanical resistance and stability (BWR 1).

3.1.5 Sustainable use of natural resources (BWR 7)

No performance assessed.

3.2 Methods used for the assessment

The assessment of fitness of the anchors for declared intended use in relation to the requirements for mechanical resistance and stability and safety in use in the sense of the Basic Requirements 1 and 4 has been made in accordance with the ETAG 001 "Metal anchors for use in concrete", Part 1: "Anchors in general" and Part 5: "Bonded anchors", on the basis of Option 7.

4 Assessment and verification of constancy of performance (AVCP) system applied, with reference to its legal base

According to Decision 96/582/EC of the European Commission the system of assessment and verification of constancy of performance (see Annex V to Regulation (EU) No 305/2011) given in the following table applies.

Product	Intended use	Level or class	System
Metal anchors for use in concrete	For fixing and/or supporting to concrete structural elements (which contributes to the stability of the works) or heavy units	–	1

5 Technical details necessary for the implementation of the AVCP system, as provided for in the applicable European Assessment Document (EAD)

Technical details necessary for the implementation of the AVCP system are laid down in the control plan which is deposited at Instytut Techniki Budowlanej.

For type testing the results of the tests performed as part of the assessment for the European Technical Assessment shall be used unless there are changes in the production line or plant. In such cases the necessary type testing has to be agreed between Instytut Techniki Budowlanej and the notified body.

Issued in Warsaw on 23/02/2017 by Instytut Techniki Budowlanej

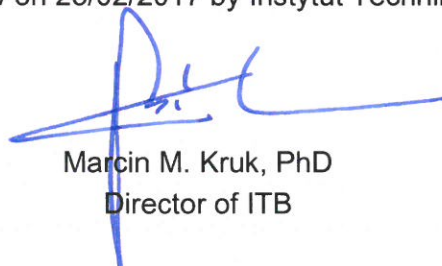

Marcin M. Kruk, PhD
Director of ITB

DETAIL A

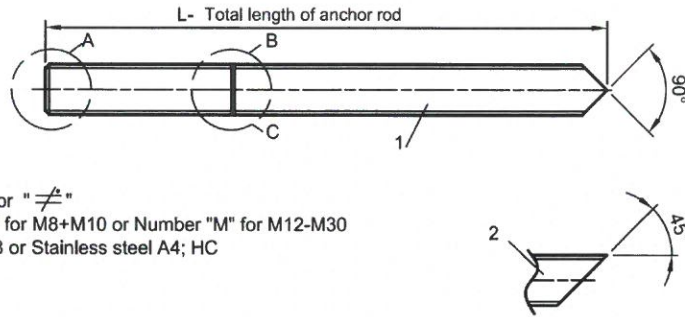

Marking:

Identifying mark: "R" or "≠"
 Rod size: Number "R" for M8+M10 or Number "M" for M12-M30
 Property class 5.8; 8.8 or Stainless steel A4; HC

DETAIL A

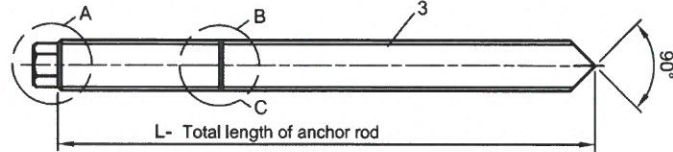

Marking:

Identifying mark: "R" or "≠"
 Rod size: Number "R" for M8+M10 or Number "M" for M12-M30
 Property class 5.8; 8.8 or Stainless steel A4; HC

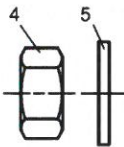

1. Anchor rod VAS: Shape 90°
2. Anchor rod VAS: Shape 45°
3. Anchor rod VAS: Shape 90°; Hex drive
4. Hexagonal nut
5. Washer

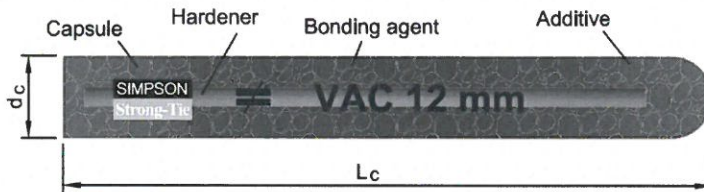

Marking:

Identifying mark: SST-Logo + ≠
 Identifying capsule: VAC
 Size rod: 8 - 30mm

VAC (glass capsules)	8 mm	10 mm	12 mm	16 mm	20 mm	24 mm	30 mm
L _c [mm]	85 ± 3%	85 ± 3%	95 ± 2%	95 ± 2%	180 ± 2%	215 ± 1%	270 ± 1%
d _c [mm]	9,25	10,75	12,65	16,75	21,55	23,75	33,2
VAS (anchor rods)	M8	M10	M12	M16	M20	M24	M30
L [mm]	110; 160; 250	130, 170, 190, 220, 250	160, 190, 220, 260, 300	190, 220, 260, 300, 310, 380	260, 350	300, 400	380

SIMPSON STRONG-TIE® - VINYLESTER ADHESIVE SYSTEM „VA”

Product description
 Characteristic of the product

Annex A1
 of European
 Technical Assessment
 ETA-13/0937

Table A1: Metal components

Part	Designation		
	Steel, zinc plated	Stainless steel	High corrosion resistance stainless steel (HCR)
Threaded rod	Steel, property class 5.8 to 12.9 acc. to EN ISO 898-1 electroplated $\geq 5 \mu\text{m}$ acc. to EN ISO 4042 or hot-dip galvanized $\geq 45 \mu\text{m}$ acc. to EN ISO 10684	Material 1.4401, 1.4404, 1.4571 acc. to EN 10088; property class 70 and 80 (A4-70 and A4-80) acc. to EN ISO 3506	Material 1.4529, 1.4565, 1.4547 acc. to EN 10088; property class 70 acc. to EN ISO 3506
Hexagon nut	Steel, property class 5 to 12, acc. to EN ISO 898-2; electroplated $\geq 5 \mu\text{m}$ acc. to EN ISO 4042 or hot-dip galvanized $\geq 45 \mu\text{m}$ acc. to EN ISO 10684	Material 1.4401, 1.4404, 1.4571 acc. to EN 10088; property class 70 and 80 (A4-70 and A4-80) acc. to EN ISO 3506	Material 1.4529, 1.4565, 1.4547 acc. to EN 10088; property class 70 acc. to EN ISO 3506
Washer	Steel, acc. to EN ISO 7089; electroplated $\geq 5 \mu\text{m}$ acc. to EN ISO 4042 or hot-dip galvanized $\geq 45 \mu\text{m}$ acc. to EN ISO 10684	Material 1.4401, 1.4404, 1.4571 acc. to EN 10088	Material 1.4529, 1.4565, 1.4547 acc. to EN 10088

Table A2: Chemical mortar

Product	Composition
SIMPSON STRONG-TIE® - VINYLESTER ADHESIVE SYSTEM „VA”	Bonding agent: Vinylester styrene free resin Hardener: Dibenzoyl peroxide Additive: Quartz sand (filler)

SIMPSON STRONG-TIE® - VINYLESTER ADHESIVE SYSTEM „VA”	Annex A2 of European Technical Assessment ETA-13/0937
Product description Specifications	

SPECIFICATION OF INTENDED USE

Use:

The anchors are intended to be used for anchorages for which requirements for mechanical resistance and stability and safety in use in the sense of the Basic Requirements 1 and 4 of Regulation (EU) 305/2011 shall be fulfilled and failure of anchorages made with these products would compromise the stability of the works, cause risk to human life and/or lead to considerable economic consequences.

Anchors subject to:

Static and quasi-static loads: M8 to M30.

Base material:

- Reinforced or unreinforced normal weight concrete of strength class C20/25 at minimum to C50/60 at maximum according to EN 206:2013.
- Non-cracked concrete: M8 to M30.

Temperature range:

The anchors may be used in the following temperature range:

- -40°C to +40°C (max. short term temperature +40°C and max. long term temperature +24°C).
- -40°C to +80°C (max. short term temperature +80°C and max. long term temperature +50°C).

Use conditions (environmental conditions):

- Elements made of galvanized steel may be used in structures subject to dry internal conditions.
- Elements made of stainless steel may be used in structures subject to dry internal conditions and also in concrete subject to external atmospheric exposure (including industrial and marine environment) or exposure in permanently damp internal conditions if no particular aggressive conditions exist. Such particular aggressive conditions are e.g. permanent, alternating immersion in seawater or the splash zone of seawater, chloride atmosphere of indoor swimming pools or atmosphere with extreme chemical pollution (e.g. in desulphurization plants or road tunnels where de-icing materials are used).
- Elements made of high corrosion resistant stainless steel may be used in structures subject to dry internal conditions and also in concrete subject to external atmospheric exposure or exposure in permanently damp internal conditions or in other particular aggressive conditions. Such particular aggressive conditions are e.g. permanent, alternating immersion in seawater or the splash zone of seawater, chloride atmosphere of indoor swimming pools or atmosphere with chemical pollution (e.g. in desulphurization plants or road tunnels where de-icing materials are used).

Installation:

- Installation temperature $\geq -5^\circ\text{C}$
- Dry or wet concrete (use category 1): M8 to M30.
- Flooded holes with the exception of seawater (use category 2): M8 to M30.
- All anchor sizes are suitable for rotary hammer drilled holes: M8 to M30.

Design methods:

EOTA Technical Report TR 029 (September 2010) or CEN/TS 1992-4:2009.

SIMPSON STRONG-TIE® - VINYLESTER ADHESIVE SYSTEM „VA”	Annex B1 of European Technical Assessment ETA-13/0937
Intended use Intended use	

Table B1: Installation data

Size		M8	M10	M12	M16	M20	M24	M30
Diameter of anchor rod	d [mm]	8	10	12	16	20	24	30
Nominal drilling diameter	d ₀ [mm]	10	12	14	18	24	28	35
Maximum diameter hole in the fixture	d _f [mm]	9	12	14	18	22	26	32
Effective embedment depth	h _{ef} = h _{nom} [mm]	80	90	110	125	170	210	270
Depth of the drilling hole	h ₀ [mm]	h _{ef} + 5 mm						
Minimum thickness of concrete member	h _{min} [mm]	120	130	140	180	230	270	340
Torque moment	T _{inst} [Nm]	10	20	40	80	120	180	300
Minimum spacing	s _{min} [mm]	0,5 · h _{ef}						
Minimum edge distance	c _{min} [mm]	0,5 · h _{ef}						

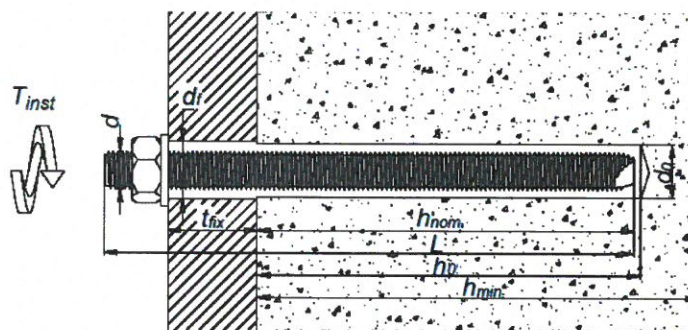

Table B2: Minimum curing time

Concrete temperature	Minimum curing time ¹⁾
-5°C	≥ 8 h
0°C	≥ 4 h
5°C	≥ 2,5 h
10°C	≥ 2 h
15°C	≥ 1,5 h
20°C	≥ 45 min
30°C	≥ 20 min
40°C	≥ 10 min

¹⁾ Curing time shall be doubled for wet concrete.

SIMPSON STRONG-TIE® - VINYLESTER ADHESIVE SYSTEM „VA”

Intended use
Installation data

Annex B2
of European
Technical Assessment
ETA-13/0937

Blow-pump (manual)

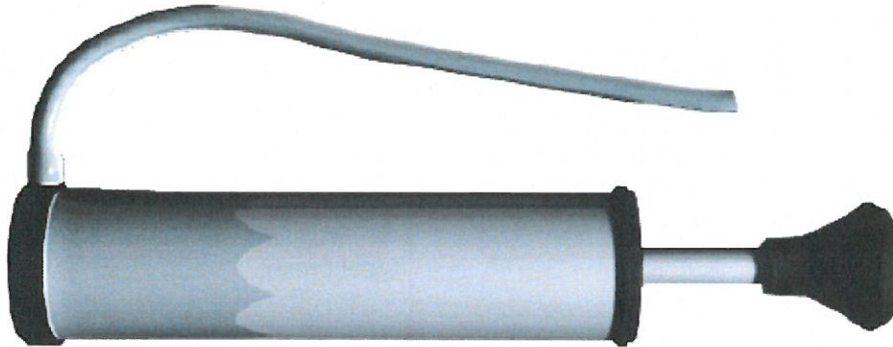

Steel brush



Size rod	M8	M10	M12	M16	M20	M24	M30
Brush diameter d_b (mm)	12	14	16	20	26	30	37

**SIMPSON STRONG-TIE® - VINYLESTER ADHESIVE SYSTEM
„VA”**

Intended use
Cleaning tools

Annex B3
of European
Technical Assessment
ETA-13/0937

	<p>Drill a hole to the required diameter and depth using a rotary hammer drilling machine.</p>
	<p>4x blowing starting from the bottom of the drilled hole using the hand pump.</p>
	<p>4x brushing (at least) using the specified steel brush.</p>
	<p>4x blowing starting from the bottom of the drilled hole using the hand pump.</p>
	<p>Insert the glass capsule into the cleaned hole.</p>
	<p>Positioning the stud into the drilled hole. Switch on the drilling machine (simultaneous hammering and turning) and drive the stud into the drilled hole until the embedment depth is reached. Setting control: Mortar excess flows out at the top of the drilled hole.</p>
	<p>Leave the fixing undisturbed until the cure time elapses.</p>
	<p>Attach the fixture and tighten the nut to the required torque.</p>
<p>SIMPSON STRONG-TIE® - VINYLESTER ADHESIVE SYSTEM „VA”</p>	
<p>Intended use Installation instruction</p>	<p>Annex B4 of European Technical Assessment ETA-13/0937</p>

Table C1a: Characteristic values of resistance under tension loads

Size			M8	M10	M12	M16	M20	M24	M30	
Steel failure										
Steel failure with threaded rod grade 5.8										
Characteristic resistance	$N_{Rk,s}$	[kN]	18	29	42	78	122	176	280	
Partial safety factor	$\gamma_{Ms}^{1)}$	[-]	1,50							
Steel failure with threaded rod grade 8.8										
Characteristic resistance	$N_{Rk,s}$	[kN]	29	46	67	126	196	282	449	
Partial safety factor	$\gamma_{Ms}^{1)}$	[-]	1,50							
Steel failure with threaded rod grade 10.9										
Characteristic resistance	$N_{Rk,s}$	[kN]	37	58	84	157	245	353	561	
Partial safety factor	$\gamma_{Ms}^{1)}$	[-]	1,40							
Steel failure with threaded rod grade 12.9										
Characteristic resistance	$N_{Rk,s}$	[kN]	44	70	101	188	294	424	673	
Partial safety factor	$\gamma_{Ms}^{1)}$	[-]	1,40							
Steel failure with stainless steel threaded rod grade A4-70										
Characteristic resistance	$N_{Rk,s}$	[kN]	26	41	59	110	171	247	393	
Partial safety factor	$\gamma_{Ms}^{1)}$	[-]	1,87							
Steel failure with stainless steel threaded rod grade A4-80										
Characteristic resistance	$N_{Rk,s}$	[kN]	29	46	67	126	196	282	449	
Partial safety factor	$\gamma_{Ms}^{1)}$	[-]	1,60							
Steel failure with high corrosion threaded rod grade 70										
Characteristic resistance	$N_{Rk,s}$	[kN]	26	41	59	110	171	247	393	
Partial safety factor	$\gamma_{Ms}^{1)}$	[-]	1,87							
Combined pull-out and concrete cone failure										
Characteristic bond resistance in non-cracked concrete C20/25	$\tau_{Rk,ucr}$	[N/mm ²]	13	12	12	11	10	9	8,5	
Increasing factor for $\tau_{Rk,ucr}$ in non-cracked concrete	ψ_c	C30/37	1,04						1,0	
		C40/50	1,07						1,0	
		C50/60	1,09						1,0	
Installation safety factor for use category 1	$\gamma_2^{2)} = \gamma_{inst}^{3)}$	[-]	1,2							
Installation safety factor for use category 2	$\gamma_2^{2)} = \gamma_{inst}^{3)}$	[-]	1,4							
Factor acc. CEN/TS 1992-4-5:2009, § 6.2.2.3 and § 6.2.3.1	$k_B = k_{ucr}^{3)}$	[-]	10,1							
Effective anchorage depth	h_{ef}	[mm]	80	90	110	125	170	210	270	
Edge distance and spacing	$c_{cr,N}$	[mm]	1,5 · h_{ef}							
	$s_{cr,N}$	[mm]	3,0 · h_{ef}							

1) In the absence of other national regulations

2) Parameter for design according to EOTA Technical Report TR 029

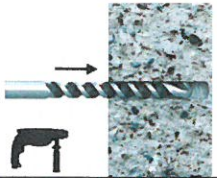
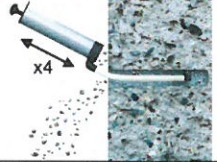
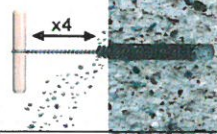
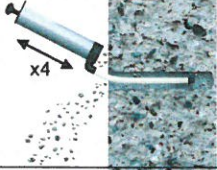
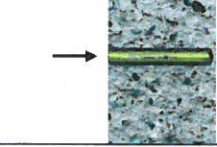
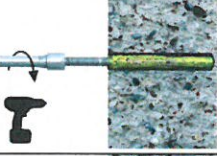
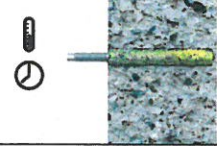
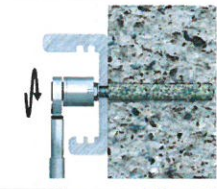
3) Parameter for design according to CEN/TS 1992-4-5:2009

**SIMPSON STRONG-TIE® - VINYLESTER ADHESIVE SYSTEM
„VA”**

Performances
Characteristic resistance under tension loads
Design method: EOTA TR 029 or CEN/TS 1992-4:2009

Annex C1
of European
Technical Assessment
ETA-13/0937

Table C1b: Characteristic values of resistance under tension loads

Size			M8	M10	M12	M16	M20	M24	M30
Splitting failure									
Effective anchorage depth	h_{ef}	[mm]	80	90	110	125	170	210	270
Edge distance and spacing	$c_{cr,sp}^{4)5)}$	[mm]	$c_{cr,sp} = h_{ef} \times \left(\frac{\tau_{k,ucr}}{8}\right)^{0.4} \times \left(3,1 - 0,7 \frac{h}{h_{ef}}\right)$						
	$s_{cr,sp}$	[mm]	$2 \cdot c_{cr,sp}$						
Installation safety factor for use category 1	$\gamma_2^{2)} = \gamma_{inst}^{3)}$	[-]	1,2						
Installation safety factor for use category 2	$\gamma_2^{2)} = \gamma_{inst}^{3)}$	[-]	1,4						

¹⁾ h = concrete member thickness

²⁾ Parameter for design according to EOTA Technical Report TR 029

³⁾ Parameter for design according to CEN/TS 1992-4-5:2009

⁴⁾ For $h/h_{ef} \leq 2,4$; if $h/h_{ef} > 2,4$ $c_{cr,sp} = 1,5 \times h_{ef}$

⁵⁾ $\tau_{k,ucr}$ from Table C1a

Table C2: Characteristic values of resistance under shear loads - steel failure without lever arm ¹⁾

Size			M8	M10	M12	M16	M20	M24	M30
Steel failure with threaded rod grade 5.8									
Characteristic resistance	$V_{Rk,s}$	[kN]	9	14	21	39	61	88	140
Partial safety factor	$\gamma_{Ms}^{2)}$	[-]	1,25						
Steel failure with threaded rod grade 8.8									
Characteristic resistance	$V_{Rk,s}$	[kN]	15	23	34	63	98	141	224
Partial safety factor	$\gamma_{Ms}^{2)}$	[-]	1,25						
Steel failure with threaded rod grade 10.9									
Characteristic resistance	$V_{Rk,s}$	[kN]	18	29	42	78	122	176	280
Partial safety factor	$\gamma_{Ms}^{2)}$	[-]	1,50						
Steel failure with threaded rod grade 12.9									
Characteristic resistance	$V_{Rk,s}$	[kN]	22	35	51	94	147	212	337
Partial safety factor	$\gamma_{Ms}^{2)}$	[-]	1,50						
Steel failure with stainless steel threaded rod grade A4-70									
Characteristic resistance	$V_{Rk,s}$	[kN]	13	20	29	55	86	124	196
Partial safety factor	$\gamma_{Ms}^{2)}$	[-]	1,56						
Steel failure with stainless steel threaded rod grade A4-80									
Characteristic resistance	$V_{Rk,s}$	[kN]	15	23	34	63	98	141	224
Partial safety factor	$\gamma_{Ms}^{2)}$	[-]	1,33						
Steel failure with high corrosion stainless steel threaded rod grade 70									
Characteristic resistance	$V_{Rk,s}$	[kN]	13	20	29	55	86	124	196
Partial safety factor	$\gamma_{Ms}^{2)}$	[-]	1,56						

¹⁾ Ductility factor acc. CEN/TS 1992-4-5:2009, § 6.3.2.1: $k_2 = 1,0$

²⁾ In the absence of national regulations

**SIMPSON STRONG-TIE® - VINYLESTER ADHESIVE SYSTEM
„VA”**

Performances
Characteristic resistance under shear loads.
Design method: EOTA TR 029 or CEN/TS 1992-4:2009

Annex C2
of European
Technical Assessment
ETA-13/0937

Table C3: Characteristic values of resistance under shear loads - steel failure with lever arm

Size			M8	M10	M12	M16	M20	M24	M30
Steel failure with threaded rod grade 5.8									
Characteristic resistance	$M^0_{RK,S}$	[Nm]	19	37	65	166	324	561	1124
Partial safety factor	$\gamma_{Ms}^{1)}$	[-]	1,25						
Steel failure with threaded rod grade 8.8									
Characteristic resistance	$M^0_{RK,S}$	[Nm]	30	60	105	266	519	898	1799
Partial safety factor	$\gamma_{Ms}^{1)}$	[-]	1,25						
Steel failure with threaded rod grade 10.9									
Characteristic resistance	$M^0_{RK,S}$	[Nm]	37	75	131	333	649	1123	2249
Partial safety factor	$\gamma_{Ms}^{1)}$	[-]	1,50						
Steel failure with threaded rod grade 12.9									
Characteristic resistance	$M^0_{RK,S}$	[Nm]	45	90	157	400	779	1347	2699
Partial safety factor	$\gamma_{Ms}^{1)}$	[-]	1,50						
Steel failure with stainless steel threaded rod grade A4-70									
Characteristic resistance	$M^0_{RK,S}$	[Nm]	26	52	92	233	454	786	1574
Partial safety factor	$\gamma_{Ms}^{1)}$	[-]	1,56						
Steel failure with stainless steel threaded rod grade A4-80									
Characteristic resistance	$M^0_{RK,S}$	[Nm]	30	60	105	266	519	898	1799
Partial safety factor	$\gamma_{Ms}^{1)}$	[-]	1,33						
Steel failure with high corrosion stainless steel threaded rod grade 70									
Characteristic resistance	$M^0_{RK,S}$	[Nm]	26	52	92	233	454	786	1574
Partial safety factor	$\gamma_{Ms}^{1)}$	[-]	1,56						

¹⁾ In the absence of national regulations

**SIMPSON STRONG-TIE® - VINYLESTER ADHESIVE SYSTEM
„VA”**

Performances
Characteristic resistance under shear loads.
Design method: EOTA TR 029 or CEN/TS 1992-4:2009

Annex C3
of European
Technical Assessment
ETA-13/0937

Table C4: Characteristic values of resistance under shear loads – pry-out and concrete edge failure

Size			M8	M10	M12	M16	M20	M24	M30
Pry-out failure									
Factor acc. to equation (5.7) of TR 029 or acc. to equation (27) of CEN/TS 1992-4-5:2009	$k^{1)} = k_3^{2)}$	[-]	2						
Concrete edge failure: see clause 5.2.3.4 of Technical Report TR 029									
Effective anchor length	l_f	[mm]	80	90	110	125	170	210	270
Diameter of the anchor	$d^{1)} = d_{nom}^{2)}$	[mm]	8	10	12	16	20	24	30

¹⁾ Parameter for design according to EOTA Technical Report TR 029

²⁾ Parameter for design according to CEN/TS 1992-4-5:2009

Table C5: Displacements under tension loads

Size			M8	M10	M12	M16	M20	M24	M30
Characteristic displacement under tension loads in non-cracked concrete C20/25 to C50/60									
Admissible service load	N	[kN]	11,5	14,2	22,1	30,0	47,3	62,9	95,1
Displacement	δ_{N0}	[mm]	0,30	0,30	0,35	0,35	0,40	0,45	0,50
	$\delta_{N,c}$	[mm]	0,65	0,65	0,65	0,65	0,65	0,65	0,65

These values are suitable for each temperature range and categories specified in Annex B1

Table C6: Displacements under shear loads

Size			M8	M10	M12	M16	M20	M24	M30
Characteristic displacement under shear loads in non-cracked concrete C20/25 to C50/60									
Admissible service load	V	[kN]	3,7	5,8	8,4	15,7	24,5	35,3	55,6
Displacement	δ_{V0}	[mm]	2,5	2,5	2,5	2,5	2,5	2,5	2,5
	$\delta_{V,c}$	[mm]	3,7	3,7	3,7	3,7	3,7	3,7	3,7

These values are suitable for each temperature range and categories specified in Annex B1

**SIMPSON STRONG-TIE® - VINYLESTER ADHESIVE SYSTEM
„VA”**

Performances
Characteristic resistance under shear loads.
Displacements under service loads: Tension and shear loads.
Design method: EOTA TR 029 or CEN/TS 1992-4:2009

Annex C4
of European
Technical Assessment
ETA-13/0937